

# FORMAT

## ATTESA

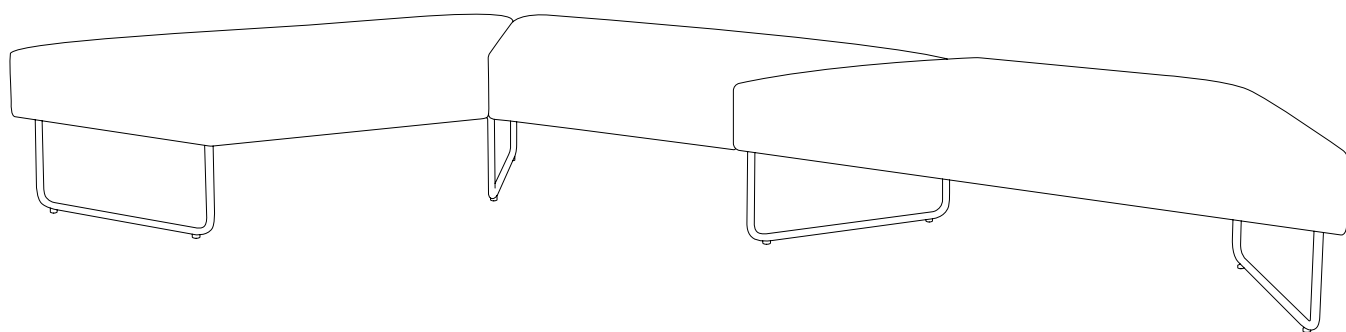





### CARATTERISTICHE TECNICHE

technical features

caractéristiques techniques

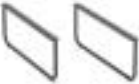
ficha tecnica

|  | IT   | EN   | FR  | ES   |
|--|--|--|---|--|
| <b>SEDILE</b><br>seat<br>assise<br>asiento                   | Legno multistrato pressato   | Plywood  | Panneau contreplaqué  | Madera contrachapada prensada  |
| <b>IMBOTTITURA</b><br>padding<br>rembourrage<br>acolchado    | Poliuretano espanso flessibile<br>spessore 16 cm<br>densità accoppiata 40-25 rc                                | Flexible, polyurethane foam<br>16 cm thick, density 40-25 rc                               | Mousse de polyuréthane<br>haute-résilience épaisseur<br>16 cm, densité 40-25 rc                           | Espuma de poliuretano<br>espesor 16 cm,<br>densidad 40-25 rc                   |
| <b>BASE FISSA</b><br>fixed base<br>base fixe<br>version fija | Gambe in tubolare ø16x2<br>con piedini regolabili.<br>Verniciate antracite o bianche<br>a polveri epossidiche. | Steel tube legs ø 16x2,<br>adjustable feet.<br>Charcoal or white epoxy<br>powders painted. | Pied en tube en acier ø16x2<br>avec patins réglables.<br>Peint anthracite ou blanc<br>aux poudres d'epoxy | Tubo de acero ø16x2 pintado<br>blanco o antracita a epoxy.<br>Pies ajustables. |

| MISURE  | CODICE ART.      | DESCRIZIONE   |
|---|------------------|---|
| <br>↑↓ 19<br>↔ 68-132<br>↗ 56 | <b>B 1640 V</b>  | Seduta modulare 60 °<br><i>Modular seating 60°</i>  |
| <br>↑↓ 22<br>↔ 56             | <b>GT 013 AT</b> | Coppia gambe terminali<br>verniciate antracite<br><i>Pair of side legs,<br/>           charcoal painted</i> |
| <br>↑↓ 22<br>↔ 56            | <b>GC 02 AT</b>  | Gamba centrale<br>verniciata antracite<br><i>Middle leg,<br/>           charcoal painted</i>                |
| <br>↑↓ 22<br>↔ 56             | <b>GT 013 B</b>  | Coppia gambe terminali<br>verniciate bianco<br><i>Pair of side legs,<br/>           white painted</i>       |
| <br>↑↓ 22<br>↔ 56           | <b>GC 02 B</b>   | Gamba centrale<br>verniciata bianco<br><i>Middle leg,<br/>           white painted</i>                      |

**COMP-F01**



Modular seating 60°

B1640V (x4)

Pair of side legs,  
white painted

GT013B (x2)

Middle leg, white painted

GC02B (x2)

**COMP-F02**



Modular seating 60°

B1640V (x4)

Pair of side legs,  
white painted

GT013B (x2)

Middle leg, white painted

GC02B (x2)

**COMP-F03**



Modular seating 60°

B1640V (x6)

Pair of side legs,  
white painted

GT013B (x3)

Middle leg, white painted

GC02B (x3)

**COMP-F04**



Modular seating 60°

B1640V (x8)

Pair of side legs,  
white painted

GT013B (x2)

Middle leg, white painted

GC02B (x6)

**COMP-F05**



Modular seating 60°

B1640V (x14)

Pair of side legs,  
white painted

GT013B (x6)

Middle leg, white painted

GC02B (x8)

**COMP-F06**



Modular seating 60°

B1640V (x8)

Pair of side legs,  
charcoal painted

GT013AT (4)

Middle leg, charcoal painted

GC02AT (x4)

**COMP-F07**

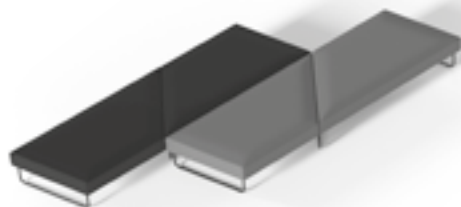

Modular seating 60°

B1640V (x4)

Pair of side legs,  
charcoal painted

GT013AT (x2)

Middle leg, charcoal painted

GC02AT (x2)

**COMP-F08**

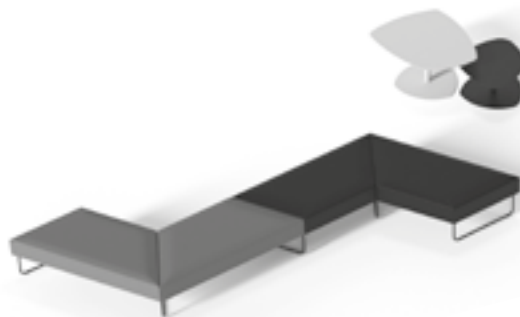

Modular seating 60°

B1640V (x4)

Pair of side legs,  
charcoal painted

GT013AT

Middle leg, charcoal painted

GC02AT (x3)